



# Instruction Manual

## DESIGNER SERIES

# NOVA

Models: DS-NO48-WH & DS-NO48-BK

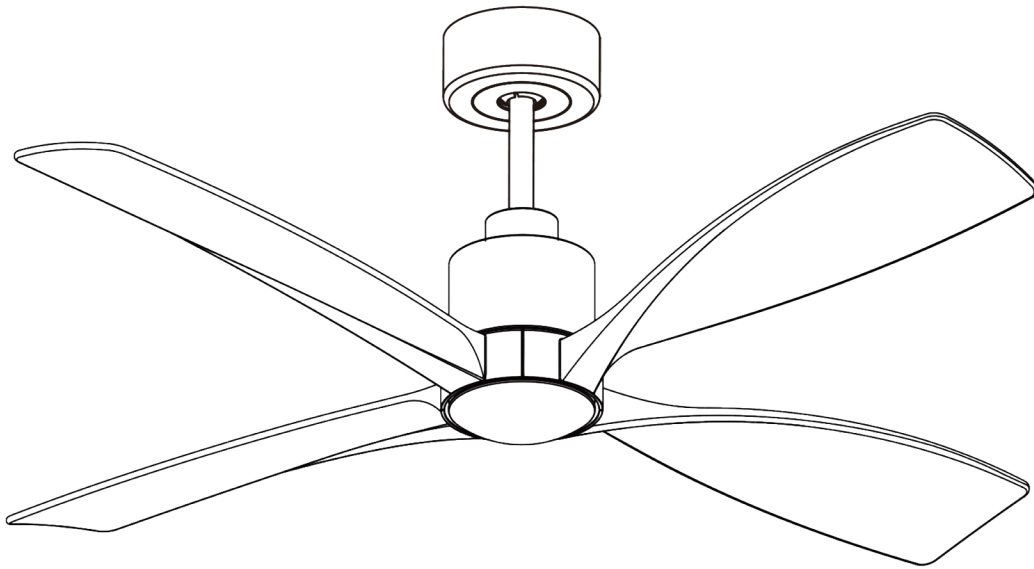

**PLEASE READ AND SAVE THESE INSTRUCTIONS**

*Attention: Pictures in this manual are for reference only.*

MADE IN CHINA

# **WARNING:**

## **TO REDUCE THE RISK OF FIRE, ELECTRICAL SHOCK, OR INJURY TO PERSONS, PLEASE OBSERVE THE FOLLOWING**

1. To ensure the success of the installation, be sure to read the instructions and review the diagrams thoroughly before beginning.
2. To avoid possible electric shock, be sure electricity is turned off at the main power box before wiring. All electrical connections must be made in accordance with local codes, ordinances and/or the National Electric Code. If you are unfamiliar with the methods of installing electrical wiring and products, require the services of a qualified and licensed electrician as well as someone who can check the strength of the supportive ceiling members and make the proper installations and connections.
3. Make sure that your installation site will not allow rotating fan blades to come in contact with any object when fan is in operation. Blades must be mounted at least 7 feet from the floor.
4. If possible, mount ceiling fan on a ceiling joist - the joist must be able to support the motion and weight of the moving fan. If the fan will be mounted on a ceiling outlet box, a 4" x 2-1/8" deep **METAL** octagon box is required; one UL listed as "suitable for fan support". The box and its supporting members must not be able to twist or work loose. **DO NOT USE PLASTIC BOXES**. Installation on a concrete ceiling should be performed by qualified personnel.
5. Blades should be attached after motor housing is hung and in place. Fan motor housing should be kept in carton until ready to be installed to protect its finish. If you are installing more than one ceiling fan, make sure that you do not mix fan blade sets.
6. After making electrical connections, spliced conductors should be turned upward and pushed carefully up into outlet box. The wires should be spread apart with the grounded conductor and the equipment - grounding conductor on one side of the outlet box and the "**HOT**" wires on the opposite side.
7. Electrical diagrams are for reference only. Light kits that are not packed with the fan must be UL/ETL listed and should be installed per the light kit's installation instructions.
8. After fan is completely installed, check to make sure that all connections are secured to prevent fan from falling and/or causing damage or injury.
9. The fan can be made to work immediately after installation. There is no need to oil your fan. The motor has permanently lubricated bearings.
10. The fan must be turned off and stopped before reversing fan direction.
11. The fan is for downrod mount only.
12. This fan is reversible.
13. This fan is controlled by remote control which is included. You can buy a wall control which is sold separately.
14. This fan is suitable for indoor use.
15. This fan is suitable for damp location.

# UNPACK & INSPECT FAN CAREFULLY TO BE CERTAIN ALL CONTENTS ARE INCLUDED

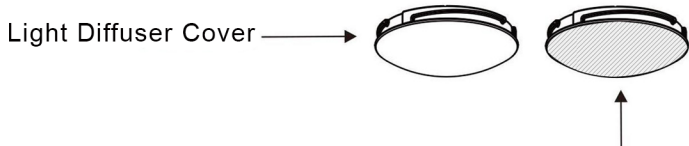
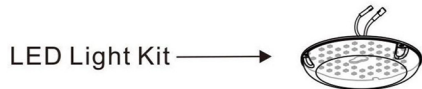
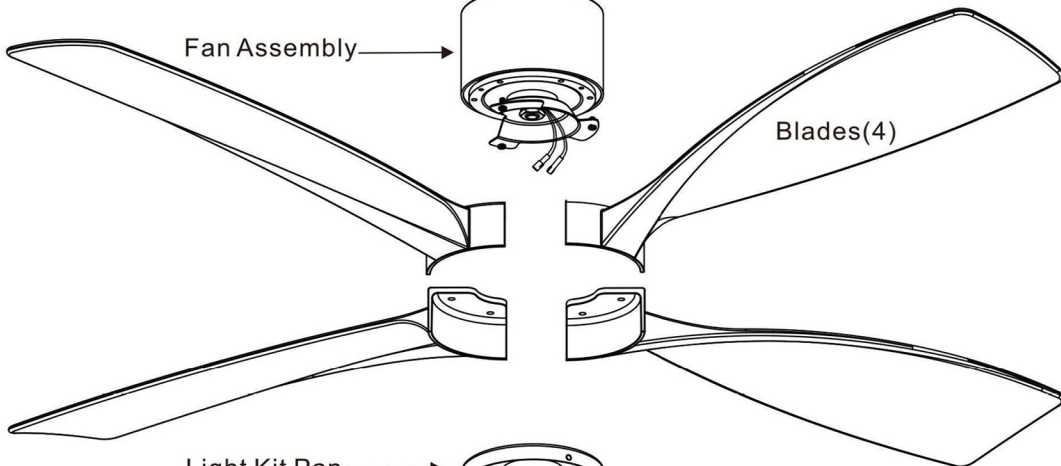
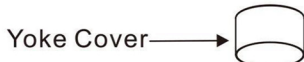
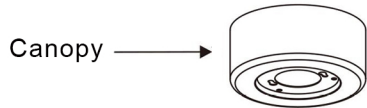
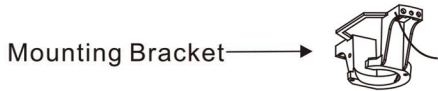



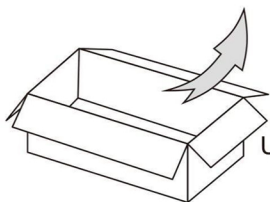



Light Delete Cover



Unit pack / all in one box









### Hardware Bag

**For Mounting Bracket:**









Flat Washer	x2		
Spring Washer	x2		
Wood Screw	x2		

**For Blade Installation:**

Flat washer x 9 (one spare washer included)



        

Blade Screw x 9 (one spare screw included)



        

**For Blade Balance :**



Balanced Slide x 1 



Weight Block (3G x 3)   







### Remote Control

**Hardware Bag**

Wood Screw x 2  

Wall plug anchor x 2  

Wire Nut x 9       

# WARNING: BLADES SHOULD BE AT LEAST 7 FEET FROM FLOOR

## Note 1:

Turn off power at breaker box to avoid possible electrical shock.

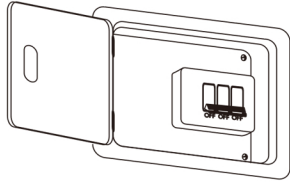

## Note 2:

Use metal outlet box suitable for fan support.  
Outlet box must support 35 lbs min.

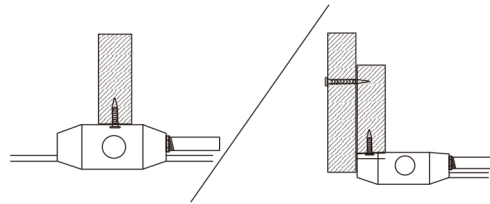

## 1. HANGING SYSTEM INSTALLATION

### 1A. Installing mounting bracket to ceiling outlet box

- ① Install mounting bracket to outlet box in ceiling by using screws included with the outlet box and washers from the hardware bag.
- ② Loosen the screws at mounting bracket.

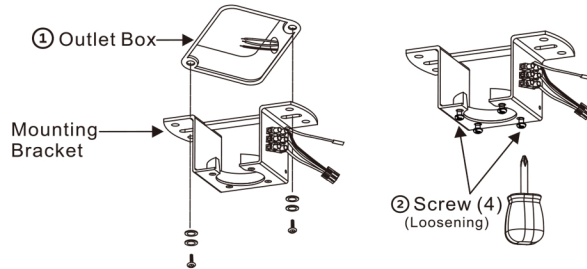

## 2. DOWNROD INSTALLATION

### 2A. Installing Downrod and Yoke

- ① Loosen the jam screw from the hanging ball and pull it down, remove the pin from downrod and keep it for step ⑥.
- ② Remove the hanging ball and keep it for step ⑥.
- ③ Remove cross pin and cotter pin from downrod and keep them for step ⑧.

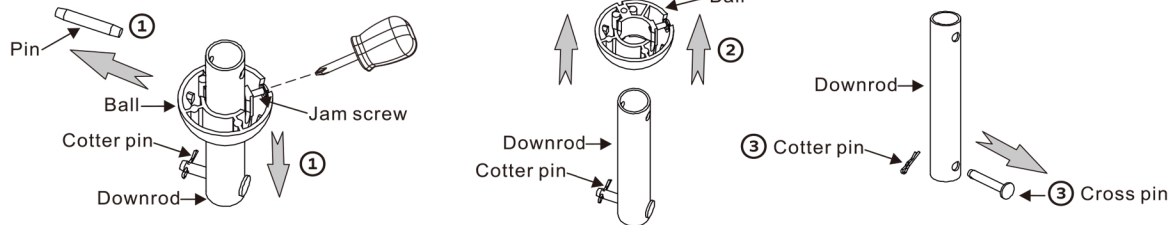

- ④ Loosen 2 downrod jam screws at yoke.
- ⑤ Insert downrod through canopy, decor ring and yoke cover, and feed motor lead wires through downrod.

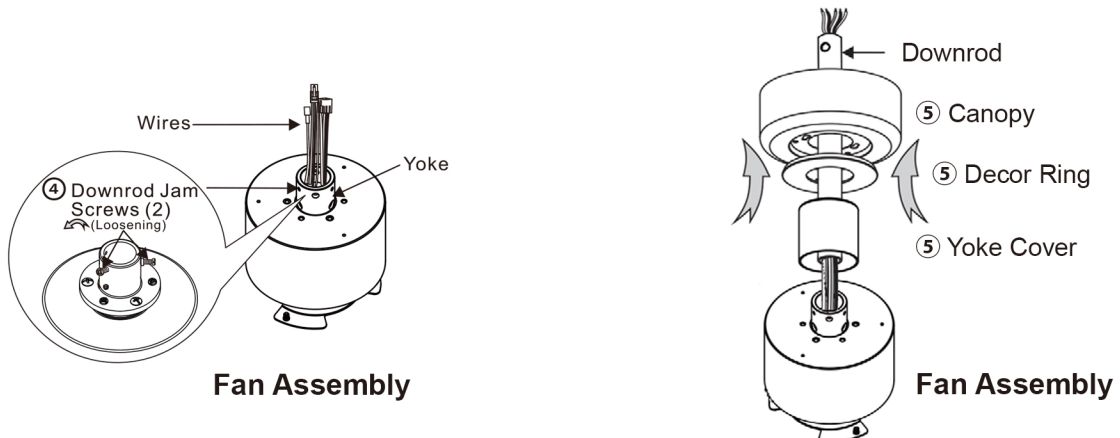

- ⑥ Insert hanging ball through downrod and insert the pin back into the downrod.  
(Removed from step ① and ②)
- ⑦ Tighten the jam screw back to hanging ball and make sure it is tight. (Loosen from step ①)
- ⑧ Insert downrod assembly into yoke, insert the cross pin through yoke & downrod and secure with cotter pin. (Removed from step ③)
- ⑨ Tighten both downrod jam screws to further secure downrod. Pull down the yoke cover to cover yoke.

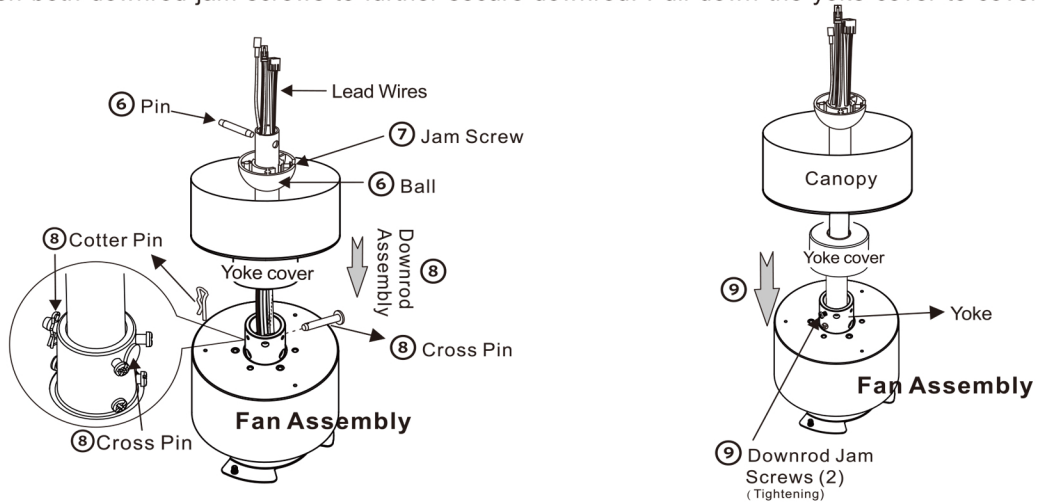

## 2B. Hanging the fan

Lift fan assembly onto mounting bracket.

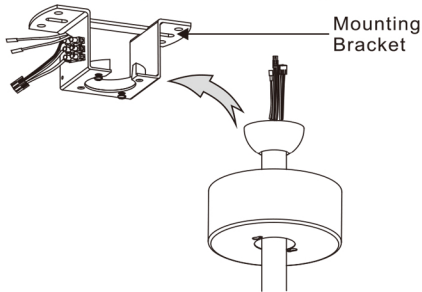

Rotate fan so that the groove on the ball engages the ridge in the mounting bracket.

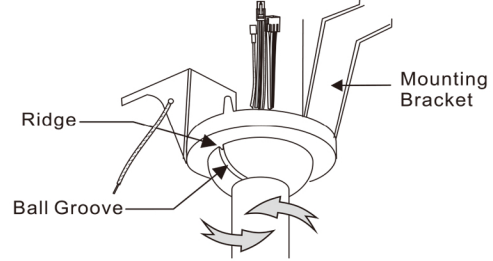

## 3. WIRE CONNECTION

### 3-1. Verify the Model Number on the Receiver

#### NOTICE:

Many remote sets for DC fans look the same. This remote set is pre-paired and labeled at the factory, please note the following before operation:

- 1a. The Remote Model Number on transmitter and receiver must be the same.
- 1b. The Remote Serial Number will be the same on a pre-paired remote set. If it is different, it will need to be paired.  
(See Remote Control Instruction Manual)
2. Check the Fan Model Number label on Receiver (DS-NO48) for proper operation.  
(There is no Fan Model Number on transmitter.)
3. Do not mix the remote sets if you are installing more than one fan.

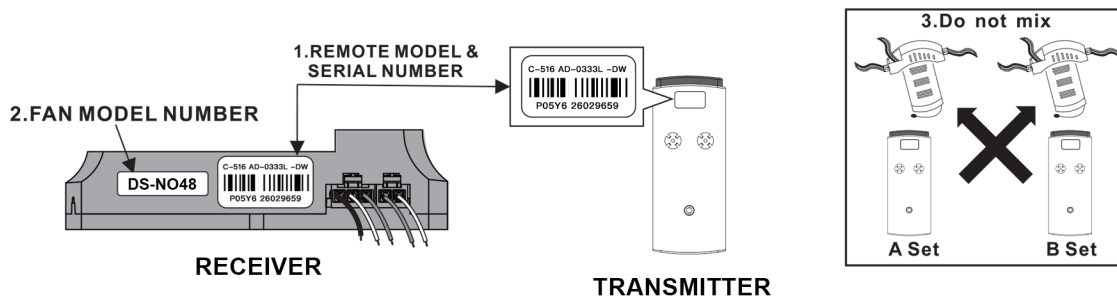

### 3-2. Insert receiver into mounting bracket

**NOTE:** Do not squeeze all the wires while inserting the receiver into the mounting bracket.

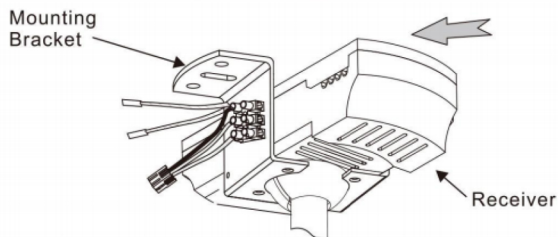

### 3-3. Making electrical wire connection

Follow diagram below and make sure that all exposed wires are secured inside wire nuts.

Note : Wires from house may vary in color. If the house wires do NOT include a ground wire (green) To prevent flickering, this unit must be grounded/earthed to the home's ground/earth; please consult an electrician.

After wiring is completed, gently push wires into junction box with wire nuts pointing upward.

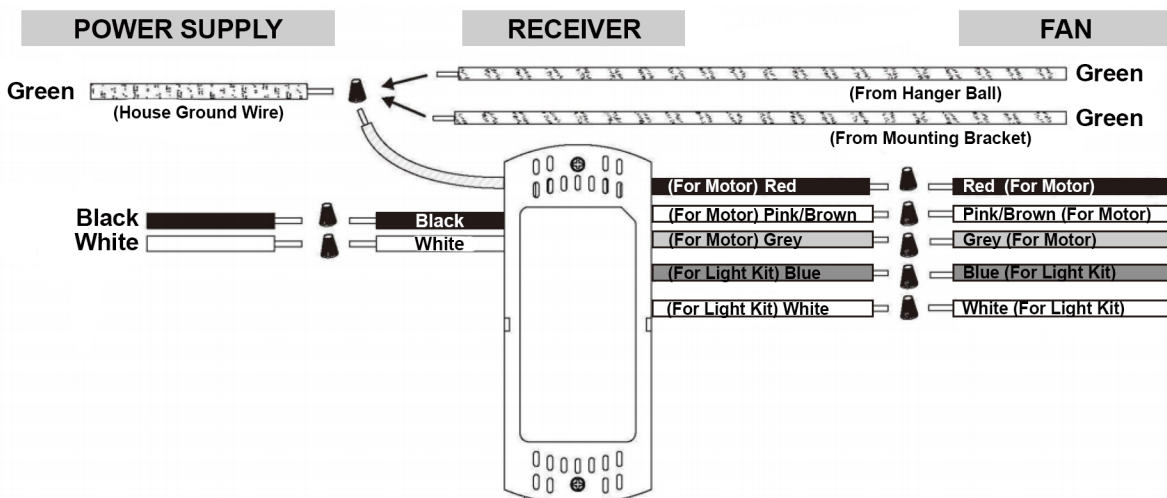

**Special note:** All yellow/green grounding wires, from Fan Assembly/Mounting Bracket, must be well attached to House Ground/Earth to prevent flickering of LED.

## 4. CANOPY INSTALLATION

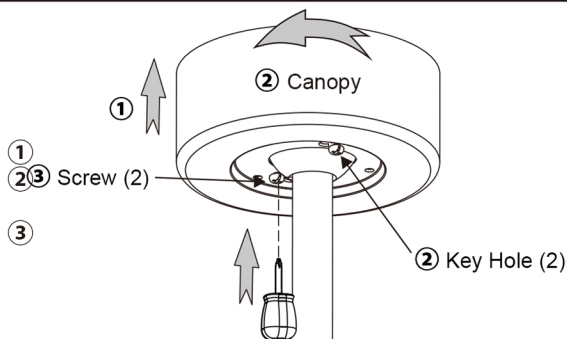

**Note:** Two screws are installed on mounting bracket for canopy installation.

- 1 Push up canopy until two pre-installed screws on mounting bracket are engaged with two key holes on canopy.
- 2 Rotate canopy slightly until two pre-installed screws heads are engaged in the narrow end of key holes.
- 3 Tighten both screws.

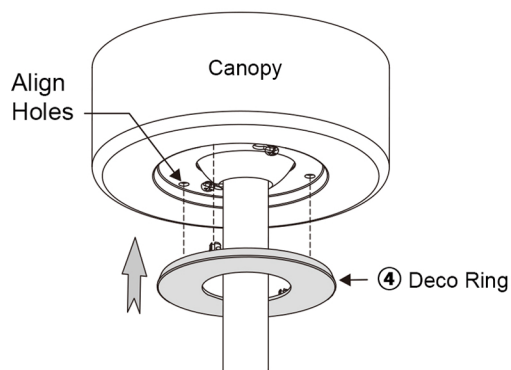

- 4 Push deco ring up to canopy, align holes on canopy with nubs on deco ring, and push to snap in.

## 5. BLADE INSTALLATION

- ① Using screws provided in hardware bag and attach blades to motor.
- ② Insert the blade between motor and connector. ( Attach the screws via slot hole from connector. )  
(\* Do this step for 4 times until 4 blades are installed firmly.)

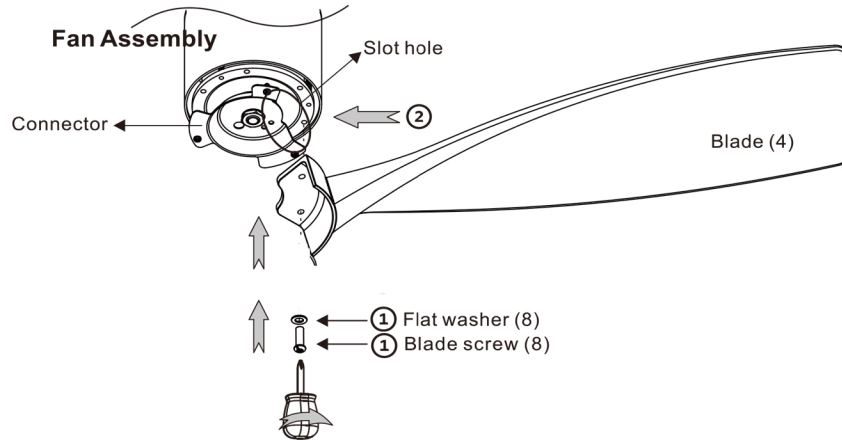

## 6. LIGHT KIT PAN INSTALLATION

- ① Loosen 3 screws from adapter.
- ② Attach Light kit pan until 3 screws on adapter are engaged with 3 key holes on Light kit pan.
- ③ Rotate Light kit pan slightly until 3 screws heads are engaged in the narrow end of key holes.
- ④ Tighten 3 screws.

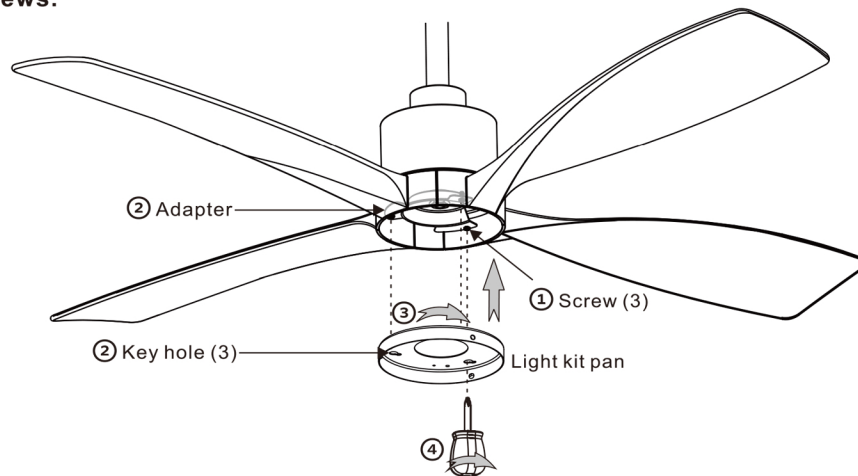

### 6A. For non Light use:

- ① Attach Light Delete Cover onto the Light Kit Pan. Align one Groove in the Light Delete Cover to one Tab on the Light Kit Pan. Secure by turning clockwise until snug. Do not over-tighten.

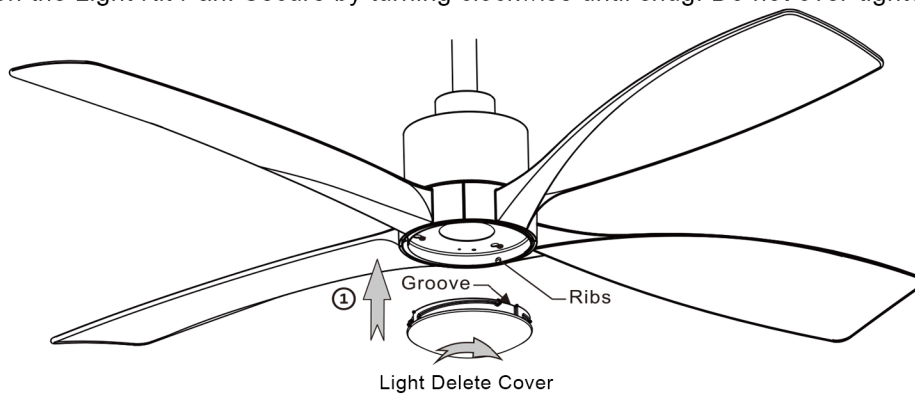

## 6B. LED Installation:

- ① Connect 2 connectors from LED Light Kit Assembly and from fan tightly.
- ② Attach LED array to Light Kit Pan and tighten by 3 screws.

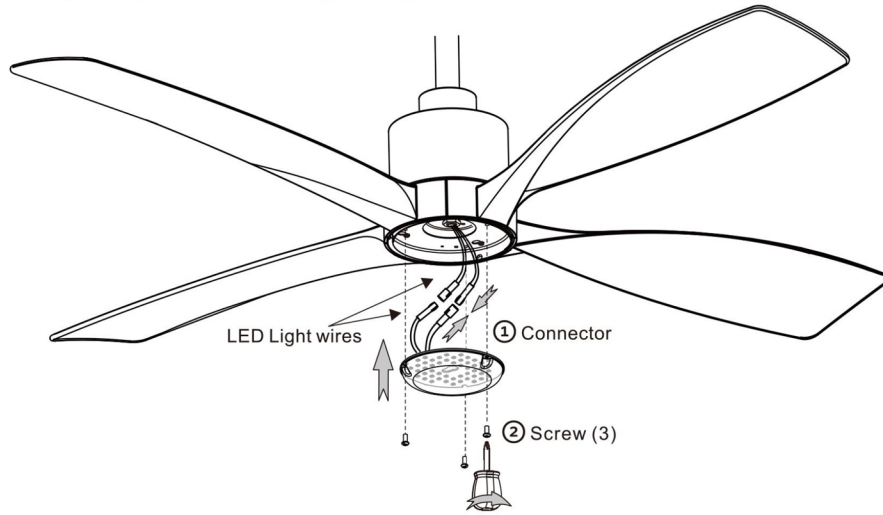

- ③ Attach Light Diffuser Cover onto the Light Kit Pan Assembly. Align one Groove in the Light Diffuser Cover to one Tab on the Light Kit Pan Assembly. Secure by turning clockwise until snug. Do not over-tighten.

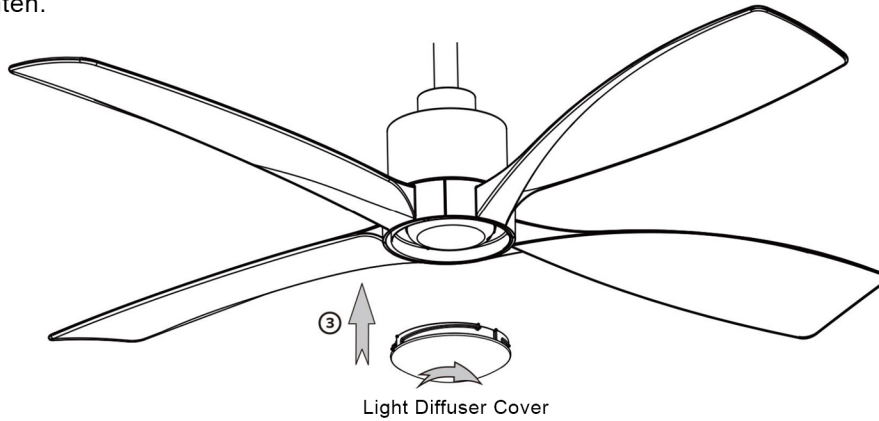

Turn on power at the breaker box. The fan is now ready for operation.  
(The receiver will emit a beep sound.)

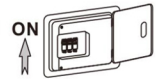

## 7. OPERATION INSTRUCTION

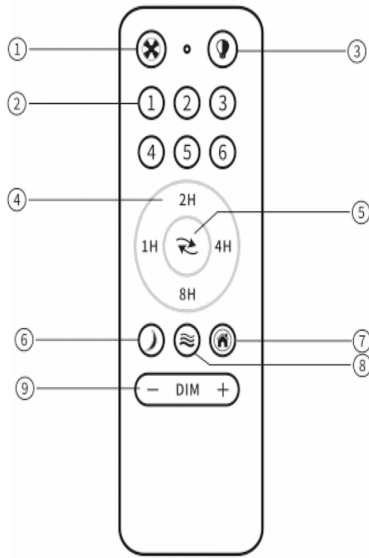

- ① Fan ON/OFF
- ② Speed of the Fan (1 Low Speed - 6 High Speed)
- ③ Light ON/OFF
- ④ Fan Timer
- ⑤ Direction of the Fan (Reverse Switch)
- ⑥ Night Light (Reduces Brightness Level)
- ⑦ Vacation Mode (Random Light ON/OFF)
- ⑧ Fan Natural Wind
- ⑨ Dimmer - or +
- ⑩ Battery - 2 x AAA (1.5V)

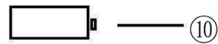

## TROUBLESHOOTING

**In the event the fan does not operate properly, please perform the following steps.**

1. Turn off power at the breaker first.
2. Lower the canopy and check that all wires are connected properly.
3. Perform the remote pairing. (See Remote Control Instruction Manual)

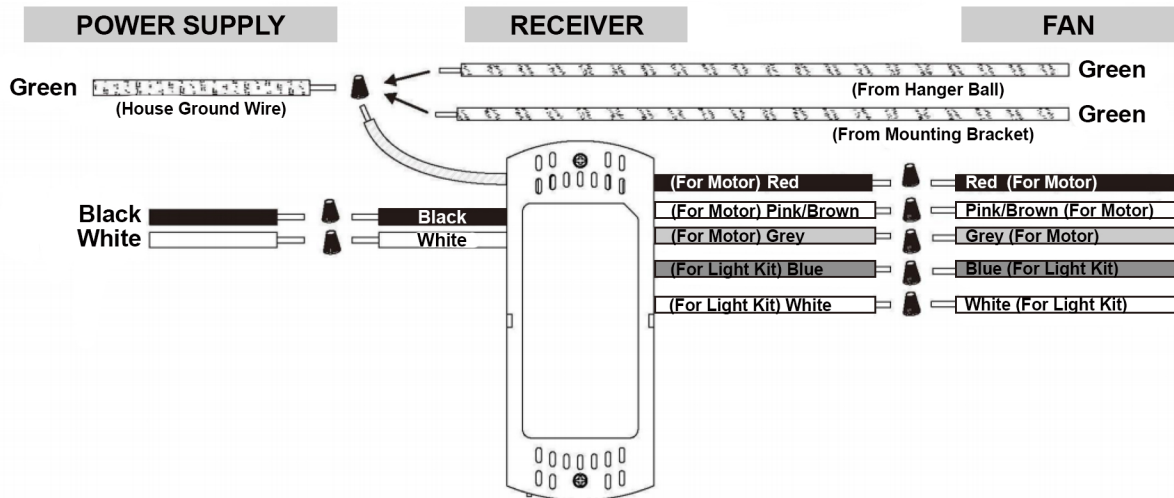

## OPERATING INSTRUCTIONS

**NOTE:** Wait for fan to stop before changing the direction of the fan. Turn on the power and check operation of fan. Speed settings for warm or cool weather depend on factors such as the room size, ceiling height, number of fan, and so on.

**Warm Weather** - (Forward) A downward flow creates a cooling effect as shown in Figure 14. This allows you to set your air conditioner on a higher setting without affecting your comfort.

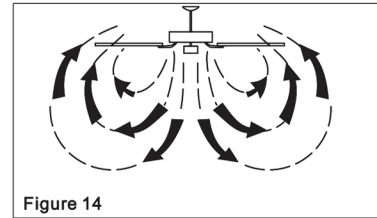

**Cool Weather** - (Reverse) An upward airflow moves warm air off the ceiling area as shown in Figure 15. This allows you to set your heating unit on a lower setting with out affecting your comfort.

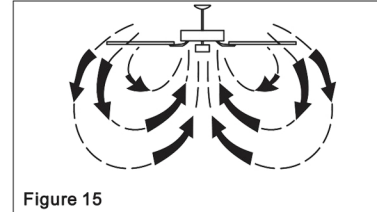

## TROUBLESHOOTING

### PROBLEM

### SOLUTION

#### Fan will not start

1. Check circuit fuses or breakers.
2. Check line wire connections to the fan and switch wire connections in the switch housing. **CAUTION: Make sure main power is off.**

#### Fan sounds noisy

1. Make sure all motor housing screws are snug.
2. Make sure the screws that attach the fan blade bracket to the motor hub are tight
3. Make sure the wire nut connections are not rubbing against each other or the interior wall of the switch housing. **CAUTION: Make sure main power is off.**
4. Allow 24-hour "breaking-in" period. Most noises associated with a new fan disappear during this time.
5. If using an optional light kit, make sure the screws securing the glassware are tight. Check that light bulb is also secure.
6. Some fan motors are sensitive to signals from solid-state variable speed controls. If you have installed this type of control, choose and install another type of control.
7. Make sure the upper canopy is a short distance from the ceiling. It should not touch ceiling.

## BANVIL LIMITED WARRANTY

Banvil warrants to the original purchaser that this ceiling fan motor is free from defects in materials and workmanship for a period of five (5) years (60 months) from the date of purchase from Banvil, or seventy-two (72) months from the date of manufacture, whichever occurs first.

All other components, including but not limited to blades, finishes, remote controls, wall controls, and light kits, are covered by a one (1) year limited warranty from the date of purchase, or two (2) years from the date of manufacture, whichever occurs first.

In the event of a defect covered by this warranty, Banvil will, at its discretion, repair or replace the defective product or component. To qualify for warranty service, please contact [returns@banvil2000.com](mailto:returns@banvil2000.com) with the reason for return, supporting photos, and proof of purchase. If the issue is deemed warranty-related, the product must be returned prepaid to:

**Banvil**

470 Industrial Ave.  
Woodstock, ON N4S 7L1

This warranty does not cover labor costs or shipping costs associated with returning the product to Banvil. This warranty is void if the product has been improperly installed, abused, misused, or altered in any way.

Banvil limits the duration of any implied warranties and excludes liability for incidental or consequential damages arising from the breach of any warranty on this product.